

# Configura<sup>®</sup>Advance



**Adjustable comfort chair** with integrated  
**pressure care** and **postural support**



**Accora**

## Design with purpose

Accora's signature intuitive and flexible design is synonymous with value for money, innovation, and performance.

This approach is embodied in the **Configura® Advance** chair, with its universal specification and fully customizable fit, making it suitable for differing care environments and a wide variety of needs.

Passionate about making lives better, Accora is driven by a desire to develop products that help pioneer new ways of working, harness abilities, and enable safe care.

"...the quality of their chair determines the quality of their life"<sup>1</sup>



The **Configura Advance** chair is a revolution in therapeutic seating design, helping to inspire excellence in care.



# Avoiding preventable harms, **improving lives**

Safe-sitting is often affected when someone is frail or acutely ill, had recent surgery, or has a neurological or progressive condition.<sup>2-4</sup>

The effects of poor seating are wide-reaching and can compromise a person's quality of life, cause preventable harms like falls or tissue damage, and sometimes lead to behavioral changes; it can place an additional burden on caregivers, too.<sup>3-9</sup> A correctly fitting armchair can help to mitigate some of these risks.



Achieving a good sitting position brings multiple benefits, including:<sup>2,3,5,6,10</sup>



Reduced fatigue



Improved respiratory function



Better nutritional intake and hydration



Security and safety



Enhanced comfort



Increased independence

It can also help relieve caregiving tasks by facilitating transfers and reducing the need for repositioning.<sup>3,9</sup>



# 75%<sup>11</sup>

of a person's weight is distributed over the buttocks and thighs when sitting.







## A foundation for health and well-being

The relationship between a seating surface and the body plays a vital role in helping maintain skin integrity, improving comfort, and encouraging a stable posture.

Older people in care facilities regularly spend extended periods in armchairs not designed for prolonged sitting.<sup>12</sup> Impaired strength, balance, or cognition can also make it difficult to sit and stand safely from an unsuitable chair or adjust position when uncomfortable or undertaking an activity.<sup>2</sup>

Having the right chair really matters.

“...research highlights the very real value in maintaining a person-centered approach to seating provision.”<sup>10</sup>

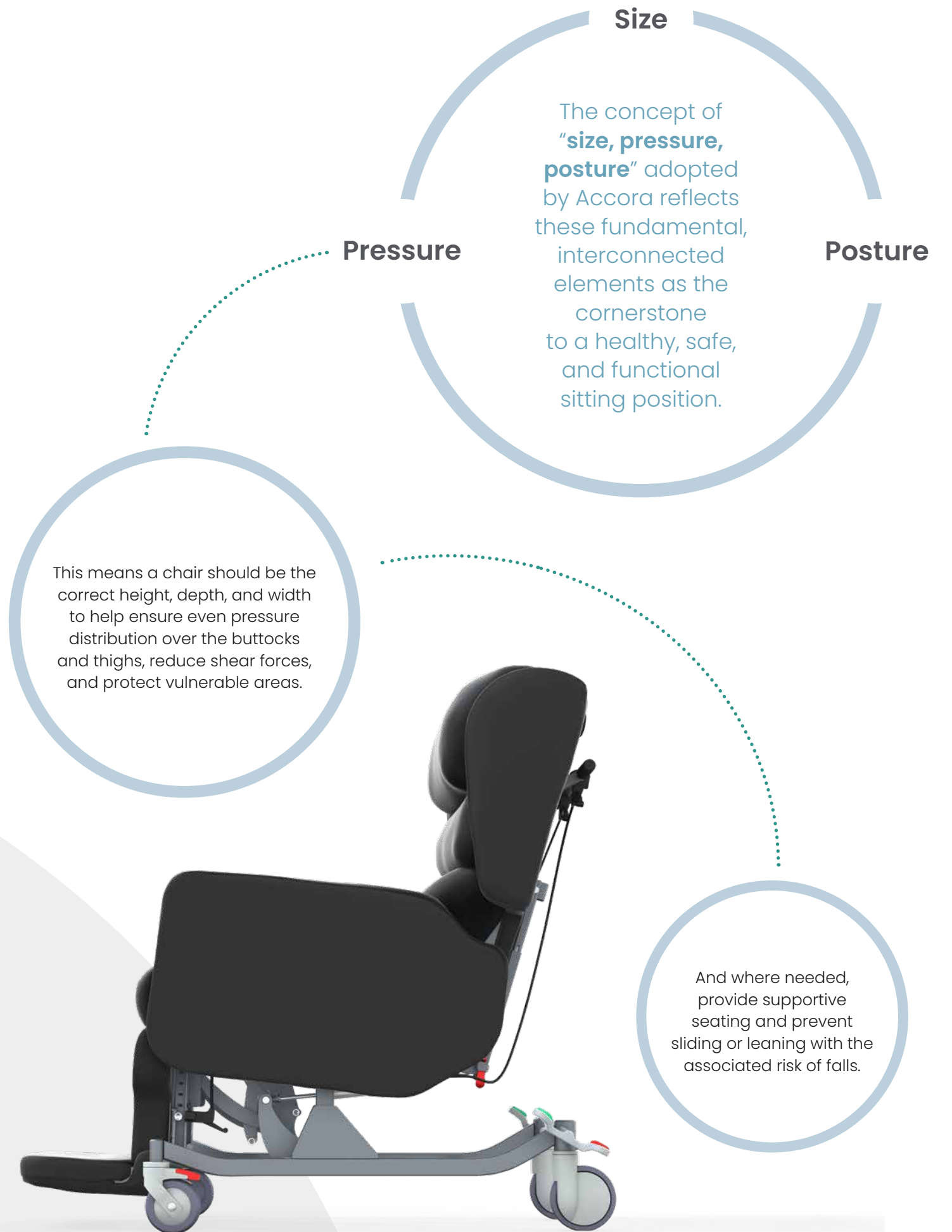





Meeting a resident's current  
and future seating needs



## Perfect fit

The multi-adjust capability, tool-less **ClickLock™ technology**, and measuring guides of the **Configura Advance** chair make it easy to create a great custom fit.

“Chairs we’ve used previously weren’t as comfortable, workable or accommodating.”<sup>13</sup>

John, Principal Occupational Therapist



“I have so much control over the positioning of my residents; I can really help them...”<sup>13</sup>

Joselito, Director of Rehabilitation



## Helping improve clinical outcomes

**Configura Advance's** seating surface is designed to help maintain a healthy skin environment and reduce the potential for deep tissue injury.

Minimizing shear and ensuring appropriate pressure care are critical factors in reducing the risk of pressure ulcer development.<sup>1,3,6-8</sup>

**BodyMove™ technology** allows the back and legrest to accommodate natural changes in the length of the spine and hamstrings when reclined or when the legs are extended, helping to reduce shear forces over the back and sacral areas and improve leg positioning.

“Our occupational therapists are overjoyed with the functionality of this chair...”<sup>13</sup>

Joselito, Director of Rehabilitation



### Adaptive BodyMove system

Reduced-shear backrest with a 130-degree recline helps maximize pelvic stability and prevent tissue damage; the fully articulating legrest also gives superior leg elevation and support.

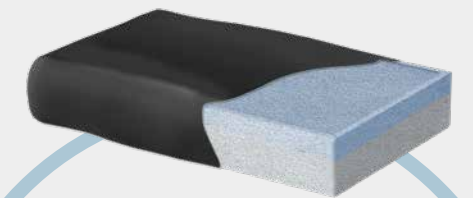

### Built-in pressure care

A visco-foam cushion suitable for individuals at high risk of developing pressure ulcers comes as standard; however, carers can easily substitute any cushion type, depending on a person's needs. And its integration with the seat base ensures zero impact on seat height.

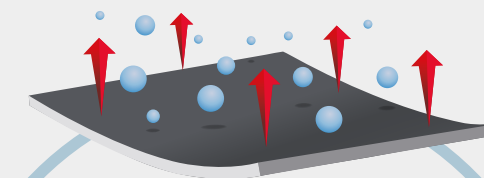

### Creating the right microenvironment

All contact areas are covered in a vapor permeable, four-way stretch fabric, helping prevent moisture and temperature build-up and maintaining a conforming and crease-free surface, which is crucial in reducing susceptibility to tissue damage.<sup>3,7</sup>





## Flexible postural support

No one's posture is the same.

So having the ability to adapt to correct this where needed can make all the difference in helping a person live their best life.

### Waterfall backrest

**Configura Advance comes with a waterfall backrest providing comfortable, cushioned support.**

Adjusting the padding or placing the cushions in a vertical orientation allows deeper immersion and is beneficial if a person has a kyphosis and where extra depth is needed to help achieve a restful and functional position.

### Tilt-in-space

**Configura's Advance's tilt-in-space mechanism retains the seat base and backrest angle when tilting the chair backward;**

this helps maintain postural alignment, increases the surface area available for support, relieves pain and pressure, and lowers the likelihood of falls.

For individuals with more complex postural requirements, there is the option of a postural backrest and lateral supports.

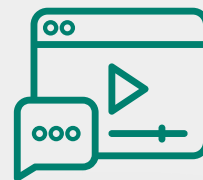

Take a closer look at  
**Configura Advance Chair**

View video to see key functionality.







.....  
Helping residents to be comfortable,  
stay social and as **independent as possible**  
.....



# Supporting “five-star” results

With the **Configura Advance** chair, you can be confident you are making the right choice.

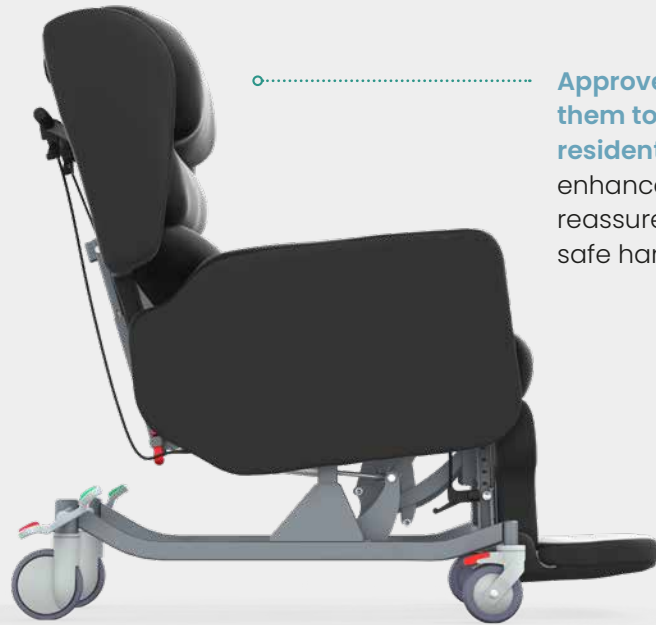

Approved by clinicians enabling them to deliver high-quality care, residents' experiences are also enhanced, with families feeling reassured their loved ones are in safe hands.

Operationally the configurability of the chair ensures high asset utilization and reduces demands on staff training.

Facilities may realize cost savings too through decreased treatment needs and hospitalization, and raised staff productivity due to residents' increased independence and reduced caregiver injury.

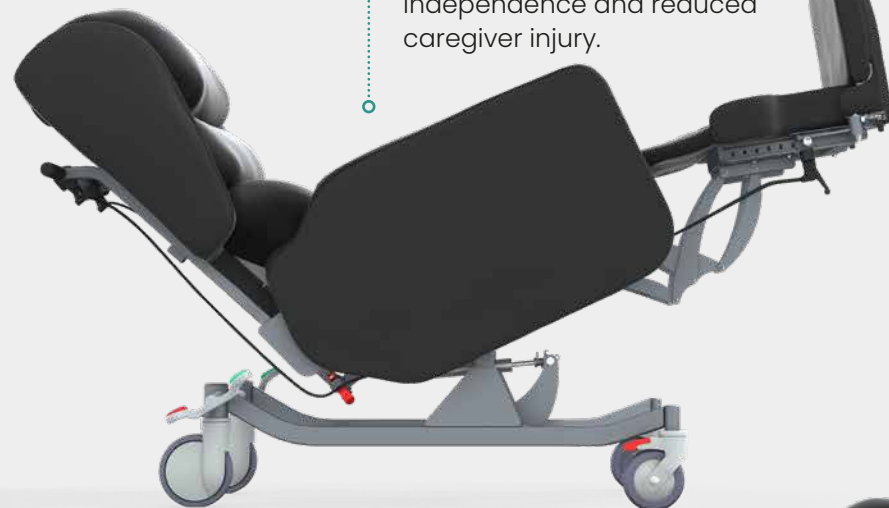

Appropriate equipment provision can also directly support key quality measures such as falls management and pressure ulcer prevention.

And favorable ratings can help improve staff retention and recruitment of new residents.

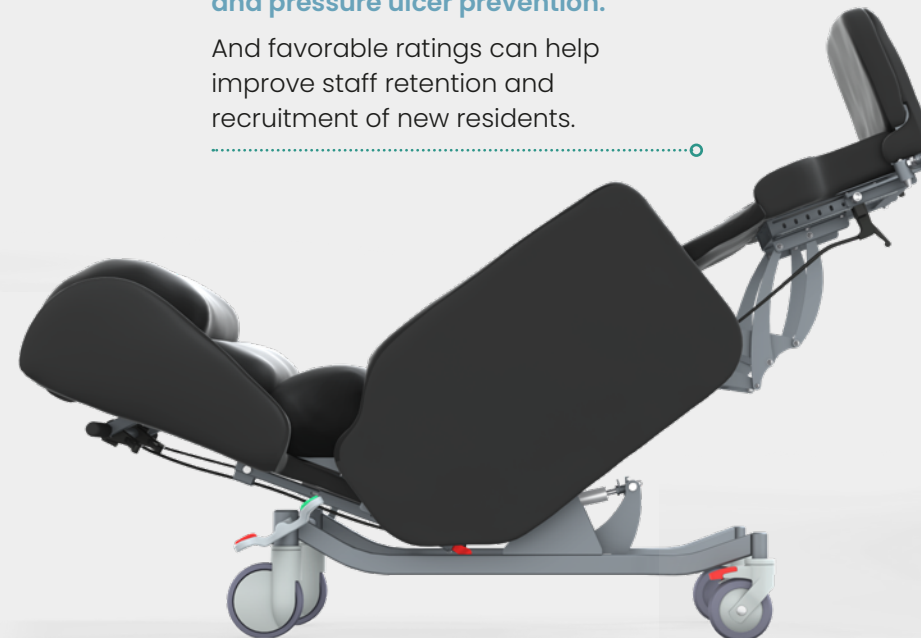

“Specialist seating provision...has the potential to impact positively on the health and well-being of residents and their caregivers.”<sup>12</sup>





# Understanding everyone's needs

A wealth of features come as standard, plus some optional ones too, supporting clinicians and caregivers in their day-to-day work and helping promote residents' health and independence.

The **Configura Advance** chair is a cost-effective and versatile solution for anyone needing more specialist seating. And with an emphasis on comfort and safety, it can contribute to a facility's reputation for excellence.

Lockable, 130° reduced shear backrest recline.

7-37° of tilt-in-space and full length articulating legrest.

Continuous seat overlay for thigh support.

Optional dropdown armrests facilitate assisted transfers and sling access for hoists.

Removable, angle-adjustable footplate provides foot and ankle support.

UniSafe™ central braking system boosts ergonomic handling and safety.

Effortless maneuverability aided by directional castors.

7-10° of forward tilt to assist transfers.

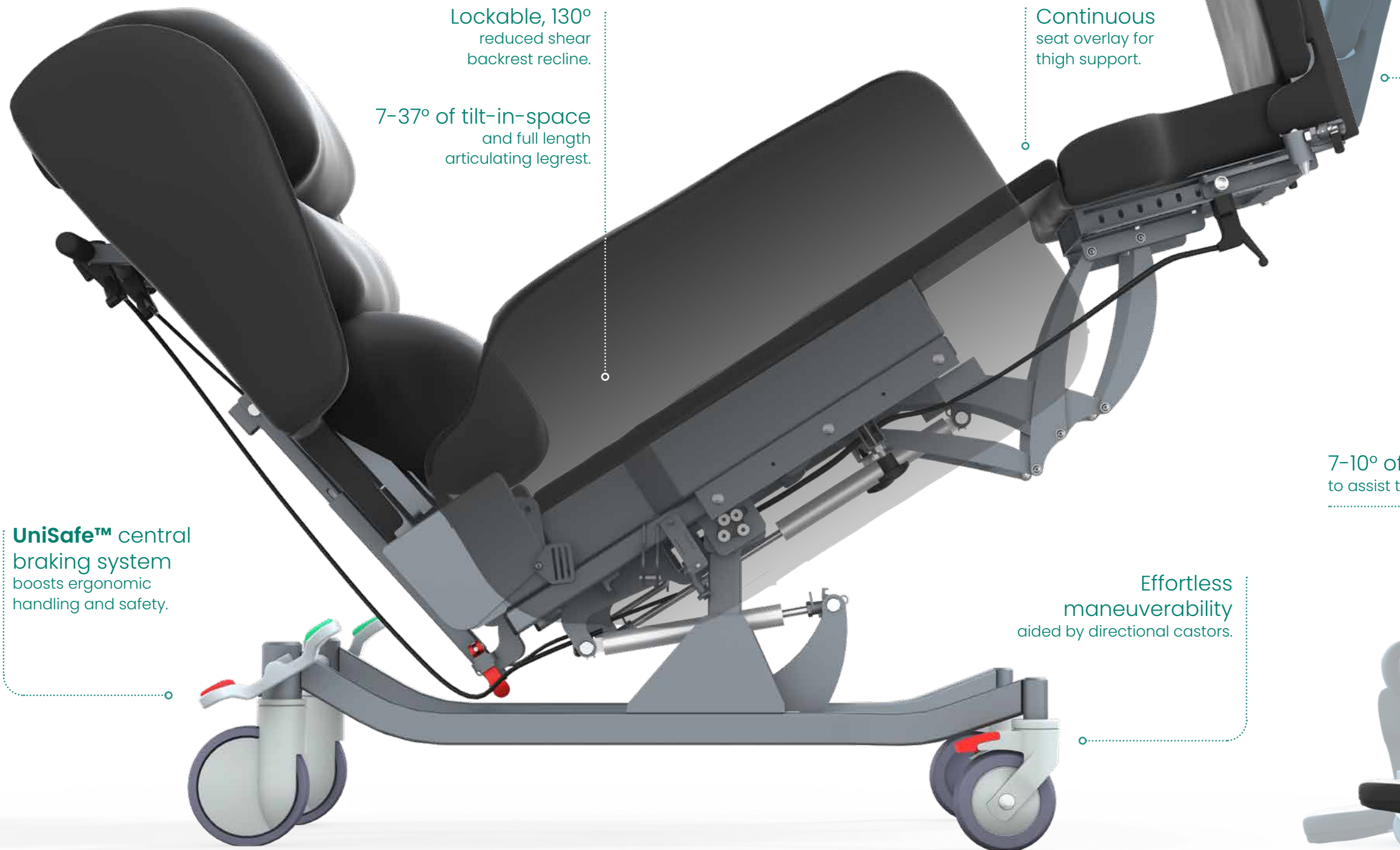

## Optional postural accessories

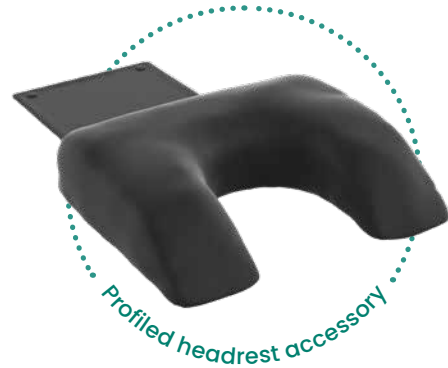

Profiled headrest accessory



Postural backrest



Lateral supports accessory

Angle-adjustable pillows

Cushions height and depth adjustable



## Technical specification

Seat height	24 in
Seat width	16-22 in
Seat depth	16-22 in
Footplate height adjustment	13-21 in
Armrest height	8 in as standard – adjustable with dropdown armrest option
Overall width	27 in
Overall height	Upright 52 in
Overall length	Without footplate 37 in
Overall length	With footplate 51 in
Total length	Fully tilted, reclined and legs elevated 74 in
Tilt-in-space range	7-37 degrees
Forward tilt	7-10 degrees
Backrest recline	130 degrees
Legrest angle adjustment	75-160 degrees
Maximum patient weight	352 lbs
Mechanism	Manual tilt-in-space
Fabric:	Vapor permeable on all contact areas; vinyl fabric on non-contact areas



The **Configura Advance** chair is suitable for

- » Non-ambulant residents
- » Residents with limited knee extension
- » Residents who need to be transported from room to room
- » Moderate postural requirements
- » Complex postural requirements, e.g., fixtures and contractures
- » Residents with stiffness or fixtures at the hips
- » Stroke and neurological conditions

## Accora resources

### Product knowledge and advice

All the information you need to get the best out of our products for your residents, provided virtually or face-to-face.

### Book a demonstration

If you would like to find out more about this chair.

Visit [us.accora.care](https://us.accora.care) for more information

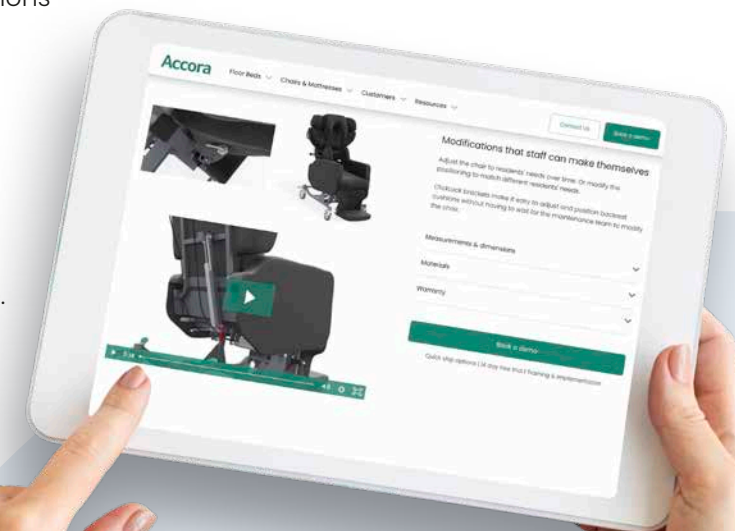



## References

1. Tierney, M. (2022) *The clinician's seating handbook: a reference guide for clinical seating provision*. 6<sup>th</sup> ed. Available from: <https://seatingmatters.com/gb-ie/> [Accessed 16 February 2022].
2. Shelstone, H. (2015) *The impact of specialist seating on a person's quality of life and functional abilities*. MSc thesis, Sheffield Hallam University, Sheffield. Available from: <http://shura.shu.ac.uk/12187/> [Accessed 10 February 2022].
3. AWTVNF, PUPIS. (2019) *All Wales best practice guidelines: seating and pressure ulcers*. Available from: [https://www.pmguk.co.uk/web/data/page\\_files/Best%20Practice/All%20Wales-Seating%20and%20PUs\\_FINAL.pdf](https://www.pmguk.co.uk/web/data/page_files/Best%20Practice/All%20Wales-Seating%20and%20PUs_FINAL.pdf) [Accessed 12 February 2022].
4. Beldon, P. (2007) Sitting safely to prevent pressure damage. *Wound Essentials*. (2), 102-104. Available from: [file:///C:/Users/User/Downloads/wound-essentials-2-sitting-safely-to-prevent-pressure-damage%20\(3\).pdf](file:///C:/Users/User/Downloads/wound-essentials-2-sitting-safely-to-prevent-pressure-damage%20(3).pdf) [Accessed 10 February 2022].
5. Blackler, A, Brophy, C., O'Reilly, M., and Chamorro-Koc, M. (2018) Seating in aged care: physical fit, independence and comfort. *SAGE Open Medicine*. (6), 1-17. Available from: [doi.org/10.1177/2050312117744925](https://doi.org/10.1177/2050312117744925).
6. Nitz, J.C. (2000) The seating dilemma in aged care. *Australian Journal of Physiotherapy*. 46 (1), 53-58. Available from: [doi:10.1016/S0004-9514\(14\)60314-7](https://doi.org/10.1016/S0004-9514(14)60314-7).
7. Stephens, M, Bartley, C.A. (2018) Understanding the association between pressure ulcers and sitting in adults what does it mean for me and my carers? Seating guidelines for people, carers and health and social care professionals. *Journal of Tissue Viability*. 27 (1), 59-73. Available from: [doi: 10.1016/j.jtv.2017.09.004](https://doi.org/10.1016/j.jtv.2017.09.004).
8. Moore, Z. and van Etten, M. (2015) Ten top tips: seating and pressure ulcer prevention. *Wounds International*. 6 (2), 11-16. Available from: <https://www.woundsinternational.com/resources/details/ten-top-tips-seating-and-pressure-ulcer-prevention> [Accessed 12 February 2022].
9. Ip, K.W.M., Sum, C.M.W., Choi, M.M.C., Yue, A.S.Y., Hui, E. and Lum, C.M. (2007) The effect of improving sitting posture in nursing home residents on the burden of care. *Hong Kong Medical Journal*. Vol 13 (Supplement 1), S4-7. Available from: <https://www.hkmgj.org/system/files/hkm0702spp4.pdf> [Accessed 17 February 2022].
10. Martin, S, Daly, O, Casey, J, Tierney, M. and McVey, O. (2014) The efficacy of prescribed seating for elders in long term settings: a pilot randomised control trial, RESNA annual conference, Indianapolis. Available from: <https://www.resna.org/sites/default/files/conference/2014/Wheelchair%20Seating/Martin.html> [Accessed 12 February 2022].
11. Trumble, H. C. (1930). The skin tolerance for pressure and pressure sores. *The Medical Journal of Australia*. ii, 724-726. Available from: [doi.org/10.5694/j1326-5377.1930.tb41843.x](https://doi.org/10.5694/j1326-5377.1930.tb41843.x)
12. Daly, O, Casey, J, Martin, S, Tierney, M. and McVey, O. The effectiveness of specialist seating provision for nursing home residents. Seating Matters/Ulster University Knowledge Transfer Partnership (KTP). Available from: <https://www.seatingmatters.com.au/wp-content/uploads/2019/09/Seating-Matters-Ulster-University-Research-Summary.pdf> [Accessed 17 February 2022].
13. Data on file



### USA:

#### Accora Inc.

9210 Corporate Blvd. Suite 120, Rockville, MD 20850

**T:** 301 560 2400 **E:** [information@accora.care](mailto:information@accora.care) **W:** [us.accora.care](http://us.accora.care)

### UK:

#### Accora Ltd

Charter House, Barrington Road, Orwell, Cambridge SG8 5QP

**T:** +44 (0) 1223 206 100 **E:** [info@accora.care](mailto:info@accora.care) **W:** [accora.care](http://accora.care)

\* and <sup>™</sup> are trademarks of Accora Limited.

As our policy is one of continuous improvement, we reserve the right to modify designs without prior notice.

# Accora

BRO-SCI-003US Rev02